



global solutions :  
local support™

## Universal Antenna Mount

The UM/L universal antenna mounting systems consist of a universal bracket and choice of 2 different length mounting tube for the most demanding customer premises antenna mounting applications. The construction is better than many of these type of mounts which are only light gauge painted steel. The Laird Technologies mounts are heavy gauge steel which goes through a galvanization (plating) process and then are powder coat painted for extra protection from the elements. Fasteners used are stainless steel. The mounting tubes have 2 sets of holes to give maximum angular flexibility during installations. The mounting systems feature a universal mounting bracket with a full 90 degrees of tilt which allows for greater versatility when dealing with the variety of installation challenges found at customer sites. Their low profile and attractive styling make it ideal for installations on various styles of buildings and in all neighborhoods, including upscale neighborhoods.

### Features and Benefits:

- Attractive styling
- Galvanized steel with grey powder coat paint
- Full 90 degree tilt adjustment
- 1.5" heavy duty steel tube for greater strength
- Extremely versatile
- Supports 150Lbs. load in both axis
- 2 Sets of holes in tube for more angular flexibility
- Base accepts Laird Technologies standard U-Bolts for pole mounting

### Applications

- Customer premises equipment
- Roof or wall mounting
- Under-eave mounting
- Interior or exterior

For sales information:

Telephone 801-572-3024

E-Mail [sales@pacwireless.com](mailto:sales@pacwireless.com)

or visit: [www.pacwireless.com](http://www.pacwireless.com)

## Mechanical Specifications: UM

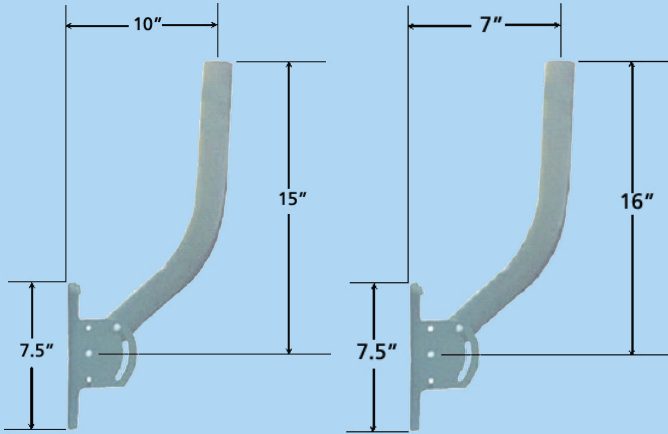

### Notes:

1. Dimensions in Inches
2. 1.5" Diameter Heavy Duty Tube
3. 90 Degree Adjustable Tilt
4. Mounting Flange 6" Wide
5. Galvanized Steel; Grey Epoxy Powder Coat Paint

## Mechanical Specifications: UML

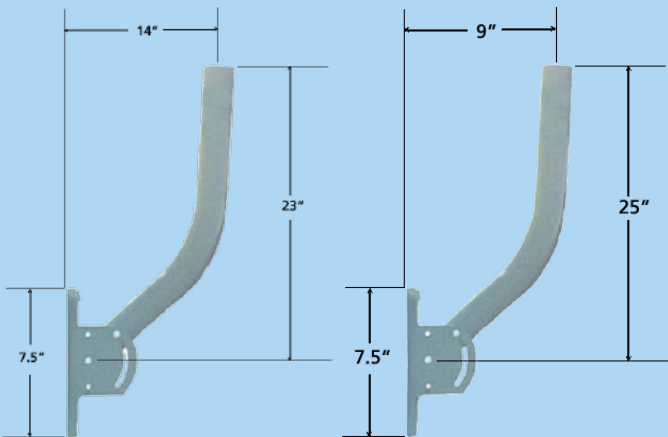

### Notes:

1. Dimensions in Inches
2. 1.5" Diameter Heavy Duty Tube
3. 90 Degree Adjustable Tilt
4. Mounting Flange 6" Wide
5. Galvanized Steel; Grey Epoxy Powder Coat Paint

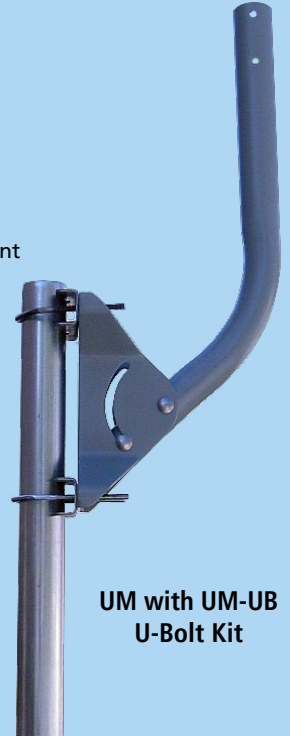

UM with UM-UB  
U-Bolt Kit

## System Ordering:

- UM – Universal Mount
- UML – Universal mount, Extra Long
- UM-UB – U-Bolt Kit for Pole Mount

## Notes:

- All shipments F.O.B. Schaumburg, IL 60173
- All antennas carry a 2 Year Warranty



Any information furnished by Laird Technologies and its agents is believed to be accurate and reliable. Responsibility for the use and application of Laird Technologies materials rests with the end user since Laird Technologies and its agents cannot be aware of all potential uses. Laird Technologies makes no warranties as to the fitness, merchantability, or suitability of any Laird Technologies materials or products for any specific or general uses. Laird Technologies shall not be liable for incidental or consequential damages of any kind. All Laird Technologies products are sold pursuant to the Laird Technologies domestic terms and conditions of sale in effect from time to time, a copy of which will be furnished upon request.

*Specifications subject to change without notice.*